

EU DECLARATION OF CONFORMITY

1. Product model: **MSPF-SH-A-7**

2. Name and address of the manufacturer or his authorised representative:

MAGICSHOOT
Reigerstraat 110
2025 XG Haarlem
The Netherlands
www.magicshoot.nl

3. This declaration of conformity is issued under the sole responsibility of the manufacturer (or installer).

4. Object of the declaration:

Equipment:

Powercable; International Extension Cord 16 A / 230VAC; constructed with: 7 meter Titanex H07RN-F 3G1,5mm² black cable and two connectors: Neutrik powerCON TRUE1 NAC3FX-W KERAFF 621 Schuko.

Brand name: MagicShoot Cable

Model/type: **MSPF-SH-A-7**

5. The object of the declaration described above is in conformity with the relevant Union harmonisation legislation:

Low Voltage Directive (LVD) 2014/35/EU,

Restriction of Hazardous Substances (RoHS) Directive 2011/65/EU,

Directive 2008/98/EC on waste (Waste Framework Directive)

6. References to the relevant harmonised standards used or references to the other technical specifications in relation to which conformity is declared:

LVD: NEN 3140+A1

RoHS: EN 50581:2012

7. Signed for and on behalf of:

Manufacturer: MagicShoot (phone: +31 6 21220846 email: info@magicshoot.nl)

Place and date: Haarlem, 16-02-2017



Sitan van Sluis, Managing Director

International Extension Cord 16 A / 230VAC

Plug / end termination	Neutrik NAC3FX-W / KERAF Schuko
Conductor size	3 x 1,5 mm ²
Cable type / color / Nom. O.D.	Titanex H07RN-F3G1.5 / black / 9,6 mm
Part Number	MSPF-SH-A-7
Length	7 m
Class	I

Partnumbering information

(following Neutrik part numbering)

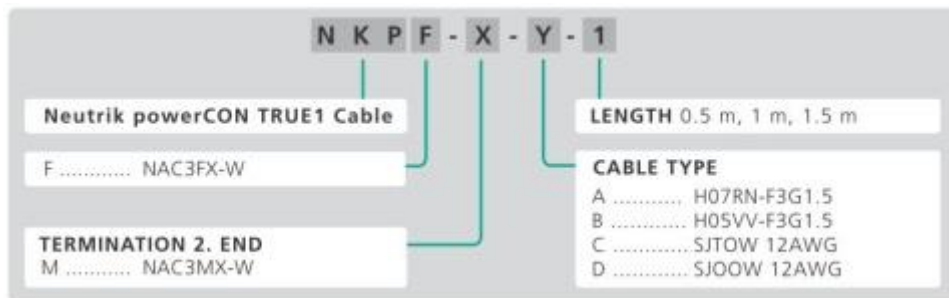

MagicShoot partnumber for two meter cable: **MSPF-SH-A-2**

SH = schucko

Schucko KERAF

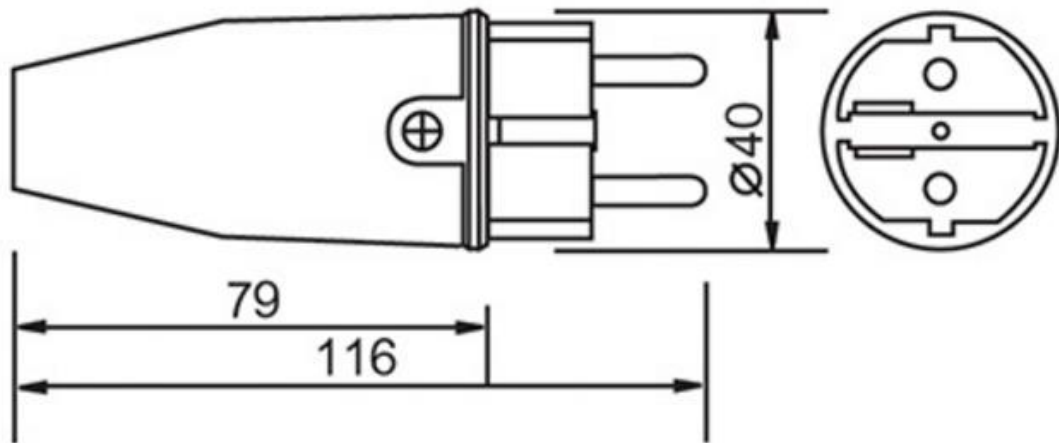

type 621

Rubber contactstop 10/16A, 250V~ 2 polig met bus- en randaarde (conform NEN 1020 en NBN C 61-112-1)

kleur : zwart

gewicht : 80 gr

Eigenschappen:

- rubber mantel
- één-schroefstelsel
- polyamide binnenwerk
- vernikkelde contacten
- parallelle schroeven met kombi-kop en reeds geopende contacten



Neutrik nac3fx-w



User Manual

International Extension Cord (powercable) for 230VAC / 16A

Push and rotate the Neutrik connector NAC3MX-W in a corresponding contra connector or chassis-part until the connector locks. Push yellow button and rotate until the connector unlocks, then pull out the connector.



OPERATING & ASSEMBLY INSTRUCTION

NAC3FX-W | powerCON TRUE1

A. OPERATING INSTRUCTION

Application:

The powerCON TRUE1 system is certified as connector with breaking capacity according IEC 60320, VDE 0625. It is intended for use as appliance couplers and interconnection couplers. It serves to supply power to an appliance and from an appliance to another equipment. To be installed by qualified person only.

Connector Assignment:

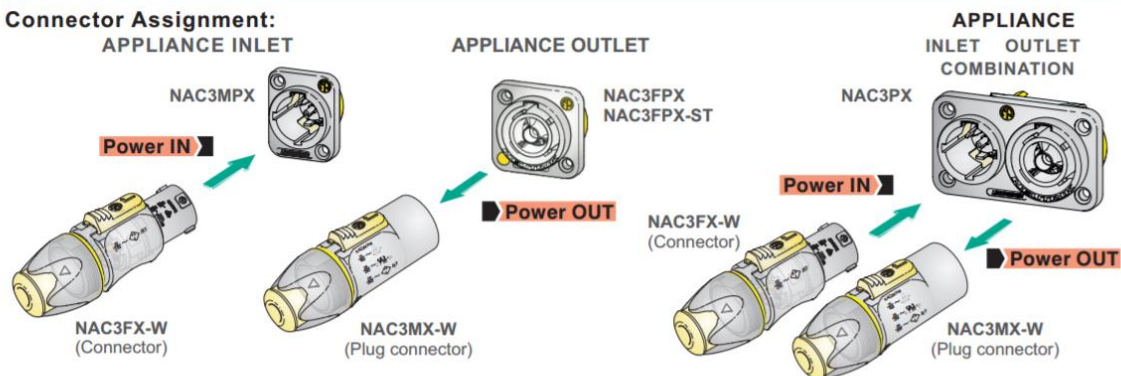

Approval based:	VDE EN 60320-1/EN60320-2-2	✓	UL UL 498 / CSA C22.2 No. 182.3	✓
Rating:	250 V ac / 16 A		250 V ac / 20 A	
Cable Type:	H05VV-F3G 1.0 mm ² , Length max. 2 m		SJTOW, SJOOW 3 x 12 AWG	
	H05VV-F3G 1.5 - 2.5 mm ²			
	H07RN-F3G 1.5 mm ²			
Strain Relief:	White chuck		White chuck	
Cable O.D.:	6.0 - 12.0 mm		6.0 - 12.0 mm	

Technical Drawing

Is this drawing molded connectors are used. We use non-molded connectors assembled according the assembly instructions on Neutrik see below.

Production/assembly information

B. ASSEMBLY INSTRUCTION

- A** Insert cable into the bushing and housing.
Note: "Apply cable pulling lubricant to cable jacket."

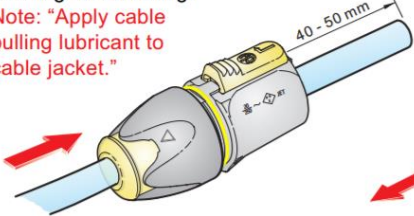

- B** Separate the housing from the bushing (cable remain in bushing)

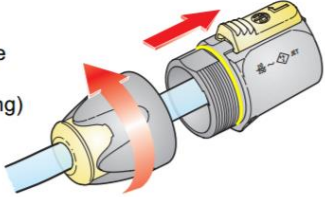

- C** Place chuck over the cable.

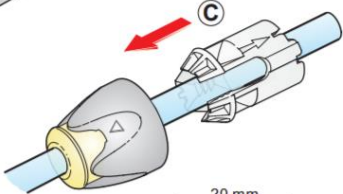

- D** Prepare cable as shown.

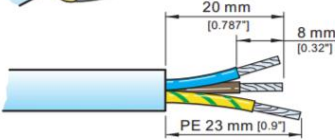

VDE (EN 60320-1/EN60320-2-2)

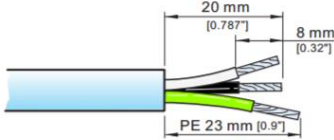

UL (UL 498 / CSA C22.2 No. 182.3)

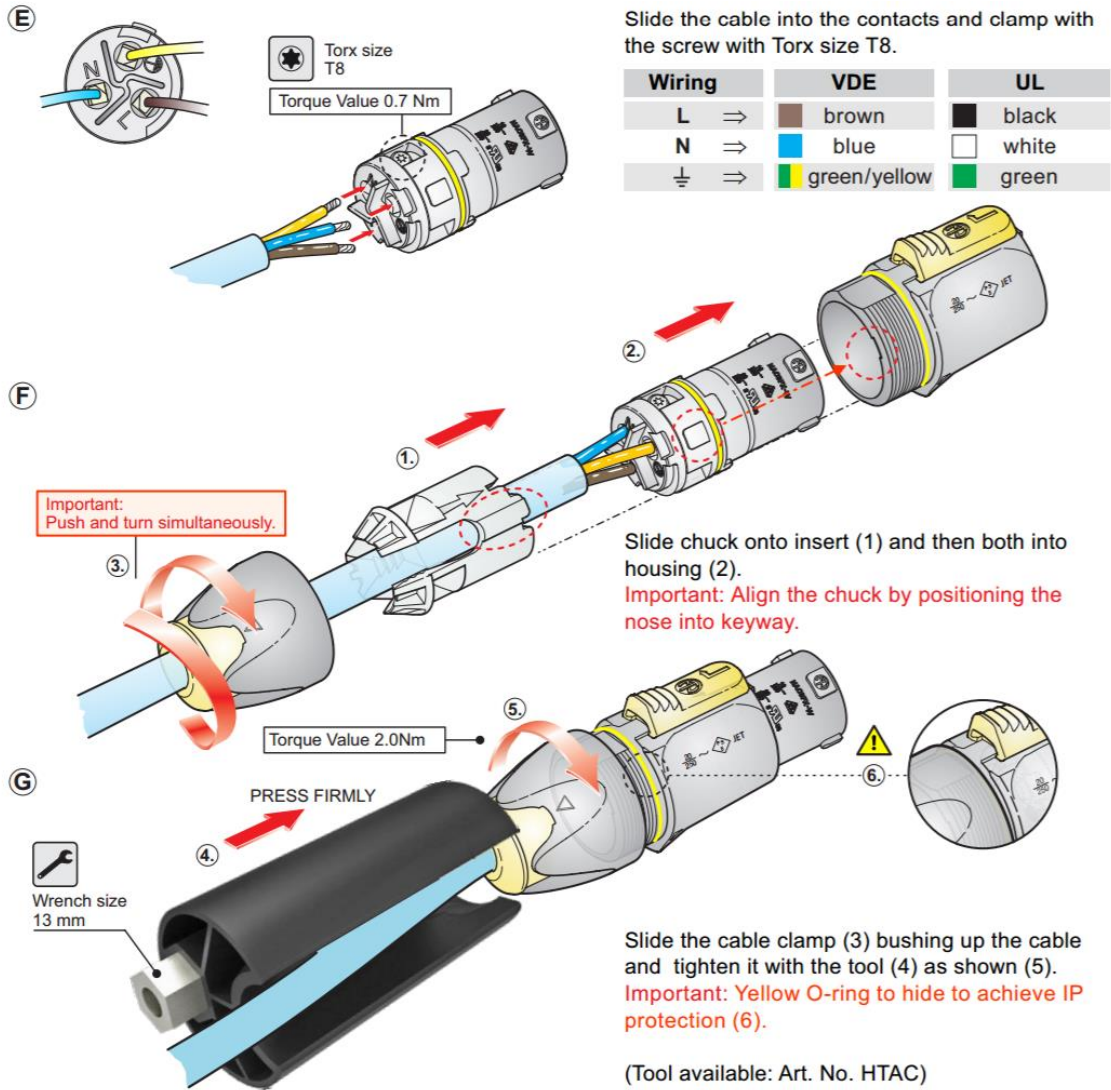

FOR DISASSEMBLY - OPEN TWIST LOCK!

- ① Press with screw driver to unlock
- ② Turn bushing 360°.
- ③ Repeat step ①+② until bushing is unscrewed.

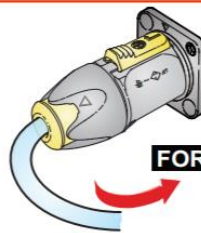
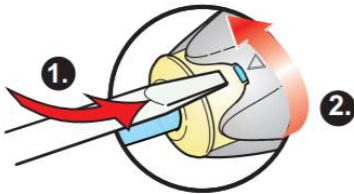

CAUTION

To ensure protection category, do not expose the connection to bending forces (e.g. do not attach loads to the cable, no free-dangling cable windings etc.).



SAFETY WARNING

For safety and certification reasons the connector must be replaced in case of any broken parts or serious damage.

Addition: we use cable end busses and a Knipex crimping tool: 97 53 04

Testing:

The cable is tested according to NEN3140:

- Visual inspection
- Measure electrical values of the cable:

Measurement device used: Nieaf-Smitt EasyPat 250V NEN3140 apparaattester

Resistance protective layer (minimal: 1 M Ω)

Resistance protective conductor (maximal: 0,3 Ω)

Max leaking current: 1mA